

Fast Charging

Twin Charger

Install Guide (Web Version)

---

Before reviewing this installation guide, please read the following information carefully.



**Pod Point is not responsible for installation and/or commissioning works performed by a 3rd party**

In the absence of any negligence or other breach of duty by Pod Point, Pod Point is not responsible for any injury, loss or damage caused by any works, services, products or equipment provided or performed by the customer or a third party (and not by Pod Point or a party for which it is responsible) in relation to the installation and/or commissioning of the Twin Charger.

If the installation and/or commissioning of the charger is not performed by Pod Point, it is the customer's responsibility to ensure that any third party appointed to install and/or commission the Twin Charger is appropriately qualified and does so in compliance with all applicable regulations and with reference to the guidance provided in this document (and associated documents linked within). Pod Point provides this guidance as a reference only and it is not a substitute for the appointment of competent persons to carry out installation and commissioning.



**Do not open, move, modify, rewire, tamper or interfere with your Twin Charger once it has been installed.**

The customer must ensure that an installed Twin Charger is not opened, moved, modified, re-wired, or otherwise tampered or interfered with, without first referring to Pod Point's latest technical guides and/or notifying Pod Point directly and complying with Pod Point's recommendations.

Please also see the charger's applicable warranty terms which may be affected by taking such action. If you have any concerns in relation to a Pod Point that has already been opened, moved, re-wired or otherwise has been tampered or interfered with, please notify Pod Point directly so that appropriate advice can be provided, noting that Pod Point assumes no responsibility for your installation by virtue of providing such advice.

In the absence of any negligence or other breach of duty by Pod Point, Pod Point is not responsible for injury, loss or damage caused by the Twin Charger being opened, moved, modified, re-wired or otherwise tampered or interfered with by the customer or a third party (and not by Pod Point or a party for which it is responsible).

## Safety Instructions



This symbol is used throughout this guide to indicate a warning. Failure to follow these warnings could result in failure of the equipment, personal injury or result in the warranty being void.



This symbol is used throughout this guide to indicate danger. Failure to follow the instructions within this guide could result in personal injury or electric shock.

- This product must only be installed and maintained by suitably qualified and competent persons.
- Pod Point recommends using only Pod Point authorised and instructed engineers for installation and maintenance services. Failure to do so may invalidate the product's warranty - please see our Warranty Terms and Conditions for more information.
- Installation and maintenance work should be carried out in accordance with the current version of BS 7671 and any other national or local regulations, legislation or guidance applicable at the time of installation. Please follow the IET Code of Practice for Electric Vehicle Charging Equipment Installation.
- It is the responsibility of the person(s) carrying out the installation work to ensure all instructions and methods described in this guide are followed at all times.
- Pod Point cannot accept any responsibility where:
  - this installation guide has not been followed
  - applicable regulations and guidance has not been followed
  - the installation is performed by someone who is not suitably qualified or competent.
- Standards, specifications and designs change from time to time. Information contained within this guide may be subject to change without notice. It is the installer's responsibility to ensure the latest instructions, standards, specifications and designs are being followed.
- To ensure electrical safety, this product must be maintained in accordance with recommendations made in this guide.
- This product must not be adapted or modified in any way, doing so could result in personal injury or damage to the product and connected equipment or cabling. Adaptations, modifications or other unauthorised interference with the product may void your warranty. Please see our Warranty Terms and Conditions for more details on this.
- Physical damage to the product may result in unsafe conditions, ensure electricity supplies are isolated and the product is not used if damaged - consult Pod Point for further information and repair.



**DANGER! Hazardous Voltage - Never make any unauthorised modifications to the internal components of this product. Ensure that the supply to the Twin Charger is isolated and locked off before installation and maintenance activities are carried out.**

| Technical specifications  | T7 Single Phase Models                                    | T22 Three Phase Models                                    |
|---|---|---|
| Charge Protocol   | EV supply equipment intended for Mode 3 charging          | EV supply equipment intended for Mode 3 charging          |
| AC Operating Voltage  | 230v AC 50Hz (per socket)                                 | 400v AC 50Hz 3P+N (per socket)                            |
| Rated Insulation Voltage  | 500VAC  | 400VAC  |
| Rated impulse Voltage   | 4kV   | 4kV   |
| Nominal Current   | 32A (per socket)<br>64A (combined)                        | 32A (per phase per socket)<br>64A (per phase combined)    |
| Rated conditional short-circuit current                                       | ≤ 75 000 A <sup>2</sup> s                                 | ≤ 75 000 A <sup>2</sup> s                                 |
| Power Output  | Up to 7.4kW (per socket)                                  | Up to 22kW (per socket)                                   |
| Earthing system   | TT, TN-S, TN-C-S  | TT, TN-S, TN-C-S  |
| Internal RCD Protection   | Type A 30mA (BS EN 60947-2) per socket                    | Type A 30mA (BS EN 60947-2) per socket                    |
| Internal DC Leakage Protection  | Internal 6mA DC detection (IEC 62955) per socket          | Internal 6mA DC detection (IEC 62955) per socket          |
| Internal Overcurrent Protection   | Internal C40A, 10 kA, 2 pole MCB (BS EN 60898) per socket | Internal C40A, 10 kA, 2 pole MCB (BS EN 60898) per socket |
| Upstream RCD Protection   | Required in some circumstances                            | Required in some circumstances                            |
| Protection against electric shock<br>Pollution Degree<br>Overvoltage category | Class I*<br>Pollution degree 3<br>Category III            | Class I*<br>Pollution degree 3<br>Category III            |
| EMC classification  | Class A (Immunity)<br>Class B (Emission)                  | Class A (Immunity)<br>Class B (Emission)                  |
| Cable Terminal Capacity   | Copper Cable Min 6mm <sup>2</sup> - max 25mm <sup>2</sup> | Copper Cable Min 6mm <sup>2</sup> - max 25mm <sup>2</sup> |
| IP (Ingress) Rating   | IP54  | IP54  |
| IK (Impact) Rating  | IK10  | IK10  |
| Environnemental use   | Indoors and Outdoors with non-restricted access           | Indoors and Outdoors with non-restricted access           |
| Operating temperature   | -25°C to 40°C   | -25°C to 40°C   |
| Height<br>Width<br>Depth  | 1330mm<br>241mm<br>295mm                                  | 1330mm<br>241mm<br>295mm                                  |
| Weight  | 19kg (19.3kg with RFID)                                   | 22.5kg (22.8kg with RFID)                                 |

*\*When not in charge mode the vehicle is galvanically isolated from the supply.*

## Product support

You can find the latest installation & technical guides on our website at: [www.pod-point.com](http://www.pod-point.com) or via the QR code.

If you have any further questions, comments, or issues regarding Pod Point Products which are not covered by this installation guide, please try our help centre ([help.pod-point.com](http://help.pod-point.com)) or contact our customer support team. You may be asked to provide the serial number of your Pod Point Twin Charger (located at the bottom of the charger).



---

## Product overview

The Twin Charger has been designed specifically for commercial applications to provide a reliable and easy to use fast charging solution - available as single phase 7.4kW and three phase 22kW variants.

The Twin Charger is compliant with the UK Smart Charge Regulations which requires a number of features to be implemented to ensure the charger is secure and the users data is protected. For more details please refer to <https://pod-point.com/guides/smart-charge-point-regulations>

The Twin Charger incorporates a number of electrical components and features to ensure safe operation for the user. Internal 30mA type A RCDs are inbuilt (per socket) which conform to BS EN 60947-2, these devices provide earth leakage protection to the socket outlets and any vehicles connected to them, each RCD is electronically resettable by manual intervention - removing the vehicle connector and reattaching. 6mA DC earth leakage protection is inbuilt (per socket) to allow the use of type A RCDs both within the Twin Charger (RCDs in the supply circuit will need to be specified in accordance with details provided on page 9 & 10) - this feature will disconnect the electricity supply to the vehicle in the event of DC earth leakage exceeding 6mA which in turn will prevent unintentional blinding of type A RCDs and ensure safe operation.

Internal supply monitoring ensures that the protective earth conductor is intact before allowing a charge cycle to start, these monitoring systems will detect an open PEN conductor condition in the supply network and disconnect the electricity supply to the vehicle - the electricity supply will only be reinstated once the supply network returns back to normal parameters and the vehicle connector has been disconnected and reattached. This monitoring system allows the Twin Charger to be safely connected to a PME earthing system.

The Twin Charger is capable of load limiting which can be set at commissioning stage. If the Twin Charger is installed as part of an Array system, active load balancing is activated ensuring the total installation capacity is not exceeded.

## What's in the box & unpacking

The Twin Charger package will include:

- Twin Charger - in specified variant
- Foundation surface mount (separate box)
- Ingress protection foundation seal
- Fixings
- Installation Guide

Remove the packaging carefully and set the Twin Charger, ingress protection foundation seal and surface mount aside. Recycle the product packaging where possible, check the contents of the packaging before proceeding with the installation - if anything is missing, please contact us immediately.

---

## Tools Required



**Specialist tools required for safe installation:**

Security torx bits

- Pin Torx T30 (upper door)
- Pin Torx T45 (lower door and ground level fixing)

Torque calibrated tools

- Torque screwdriver for electrical connections
- Torque wrench for foundation fixings

## Pre installation checks

Before starting the installation, please confirm the following:

- A suitable power source has been made available taking into consideration the power requirements of the Twin Charger being installed - design of the electrical installation should only be carried out by a suitably trained and competent person.
- The proposed site has been selected in order to minimise the risk of damage to the Twin Charger and to ensure the Twin Charger can be used correctly.
- Twin Charger Connectivity

Your Twin Charger must communicate with our servers in order to:

- Validate it's Warranty
- Receive over-the-air updates and functionality improvements
- Enable remote maintenance and asset monitoring
- For you / the hardware owner to control access, tariffs and provide usage insight data

Before commencing installation you should determine which communication type your installation will utilise:

1. 3G/4G Mobile connectivity
2. Wi-Fi only

Please note:

When using Option 1;

- The presence of a 3G/4G router is determined by “-RO” at the end of the product SKU on the box and/or Twin Charger.
- When using mobile connectivity only 1 Twin Charger in 5 will require a Router providing the Twin Chargers are sited in adjacent parking bays i.e. within c.25m of uninterrupted line of sight. The remaining 4 Twin Chargers will be able to link with a Wi-Fi hotspot created by the Twin Charger with a Router.

When using Option 2;

- A good quality WiFi signal must be available(2.4GHz only) - additional AP(Access Points) may be required to strengthen signal
- Twin Chargers will lose communication if the Wi-Fi password is changed, Wi-Fi contracts are not paid etc - this loss of communication remains the Landlord / Owners responsibility

## Groundworks

The surface mounting foundation adapter is used to secure the charger to the foundation. A purpose laid 600 x 600 x 400mm (WxHxD) level concrete pad must be used to mount the adapter - fixing to tarmac, block paving or other surfaces is not recommended.

The surface mounting plate is secured to the ground using four M10 x 120mm minimum expanding countersunk concrete anchor bolts (or preferred equivalent fixing).

Supply cables are to be routed into the bottom of the charger ensuring the duct is centralised to allow the ingress protection foundation seal to be fitted correctly. The maximum duct size is 110mm.

The Twin Charger and associated signage should not obstruct the pavement or other public footway. Under no circumstances should the width of a public footway be restricted to less than 1m, preferably not less than 1.5m. A minimum of 300mm should be left between the back of the Twin and any obstruction (e.g. wall) to allow access to the charger.

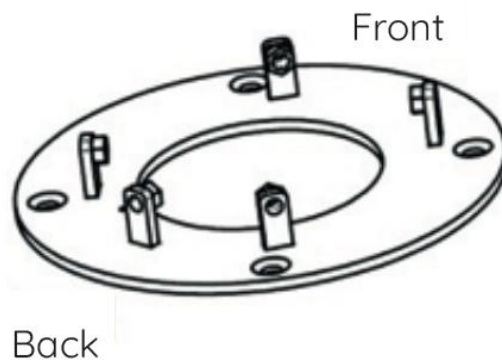



**Fig 2. Surface Mount**

Fig 2. Shows the Twin Charger foundation mount and its orientation.

## Earthing Arrangements

The Twin Charger must be connected to a permanent, metallic earthing system in accordance with the current version of BS 7671 and any other applicable local and National regulations.

The Twin Charger is suitable for connection to the following earthing systems:

| TN-C-S (PME)  | TNS   | TT*   |
|---|---|---|
|  |  |  |

**The Pod Point Twin Charger has built in PME fault protection which means it can be connected to a PME (TN-C-S) earthing system <sup>1</sup>**

<sup>1</sup> PME fault protection is disabled when the Twin Charger forms part of an Array system.

The installer is responsible for ensuring that the earthing system used is adequate and meets the requirements detailed within the current version of BS 7671.

Further checks pursuant to BS 7671 should be made when the Twin Charger is connected to a TT earthing system. An RCD will **always** be required at the source of supply where a TT earthing system has been used - either for the whole installation or locally for the charger only, our recommendations for the type of RCD can be found on page 8, 9 and 10.

Where a RCD is providing protection to more than one vehicle connector socket outlet, cumulative DC leakage currents should be considered - Please ensure compliance to BS 7671 (722.531.3) is met.

Further technical & earthing systems Information can be found here:

[Pod Point Earthing Systems Guidance](#)



## Electrical connection

Cables being terminated to the Twin Charger must be done so to avoid unintentional damage - appropriate cable glands **must** be used at the point of entry to the cable connection enclosure (DBOX), cables must be stripped to the correct length to avoid excess copper showing at the termination. Terminations must be tightened within the specified torque of:

### 2.5 Nm

Cables must be correctly identified by colour within the connection enclosure (DBOX).

## Electrical connection

Start by carefully removing the access door from the rear of the charger (note the door is connected to the main charger body via an earth cable - please ensure this is not strained or damaged). The Distribution Box (DBOX) is located towards the bottom of the charger with a see-through lid. Unscrew the lid and safely set aside, unscrew & remove the lower Gland Plate in preparation for installation of the cable gland(s).

The gland plate will need to be drilled to fit an appropriate sized gland(s) for the incoming cable(s) to enter through.



**It is essential that incoming supply cables are correctly glanded and secured into the charger to ensure the safety of the product is maintained.**

Once the gland plate has been drilled and an appropriate gland fitted, re-attach the Gland Plate to the bottom of the DBOX in preparation for the installation of the supply cable(s).

Both single and three-phase Twin Chargers come pre-configured for single supplies (1 supply circuit providing power to both charging sockets) this can be adjusted for dual supply installations. The Twin Charger connection points within the DBOX will initially be configured as in **Fig 3**.

Twin Chargers specified with an RFID and/or Router, will be supplied with a 12V aux power supply, this will be pre-installed inside the DBOX. You will not need to do any additional wiring for these variants, however for reference the initial configuration will instead be as in **Fig 4**. below:

Please now refer to the relevant wiring instruction, T7 single phase or T22 three phase.

**Fig 3. Initial Configuration of DBOX**

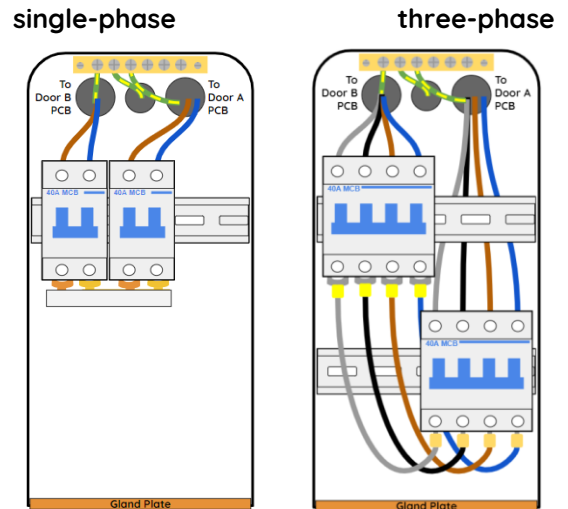

**Fig 4. Initial Config of DBOX (with 12V)**

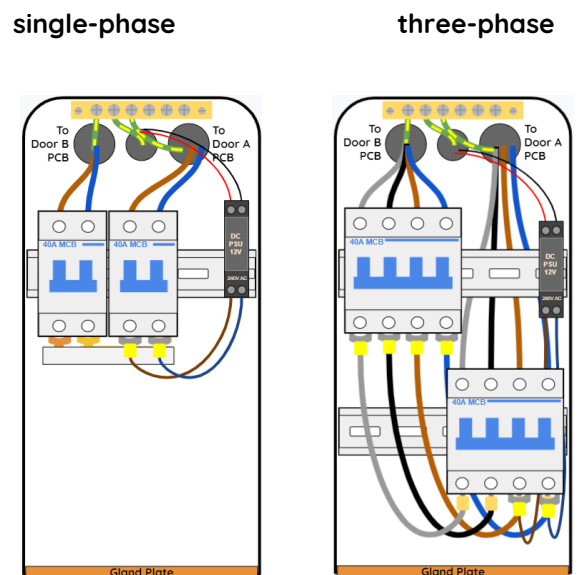

## Single-phase (T7) Installations

Single phase T7 Twin Chargers require a 230V AC supply capable of supplying 32A per door. This can be achieved using a **Single Supply**, **Dual Supply** (2x single phase circuits) or a **Polyphase Supply** (2 phases of a three phase system and a common neutral). Cables must be suitable for the installation method chosen and be adequately protected against mechanical damage / stress. Circuits and supply cables must be able to carry the nominal load current and combined prospective fault current for the Twin Charger. The Twin Charger must be protected against overcurrent and fault at the source of supply by a suitably rated MCB, MCCB or fuse (see below for current ratings).



**DANGER! If the Twin Charger is to be connected to a TT earthing system, an RCD must be provided at the source of supply.**

Where there is a requirement for a RCD to be fitted in the supply circuit, for example where a TT earthing system is being used, it must be of time delayed type with a rating over >100mA to avoid conflict with the in-built 30mA RCDs - for single supply and polyphase arrangements cumulative DC leakage currents should be considered - Please ensure compliance to BS 7671 (722.531.3) is met. For dual supply arrangements (individual circuit per charging socket) the RCD should be at least **type A - type AC RCDs must not be used.**

### Single Supply (80A, 1 phase) 1x 3-Core Cable (1 phase + Neutral)

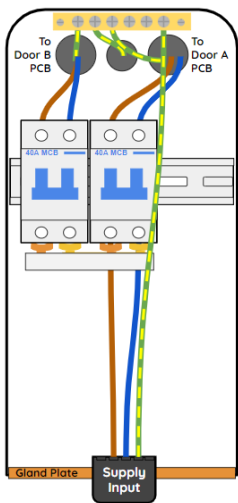

Route the supply cable into the DBOX through the cable gland. Install the **Live & Neutral** supply cables into the cable terminals on the Right side MCB (**Door A**). These should be pre-connected to the Left MCB (**Door B**) via a pre-installed 2-Pole 4-way Fork Busbar - verify that the fork busbar is correctly connected. Connect the CPC to the Earthing terminal at the top of the DBOX.

### Single Supply - Polyphase (80A, 3 phase) 1x 5-Core Cable (2 phase + common Neutral)

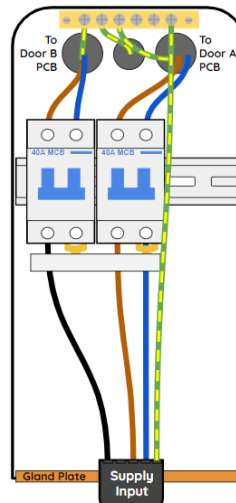

Route the supply cable into the DBOX through the cable gland. Remove the pre-installed 2-Pole 4-way Fork Busbar, remove the end cap and remove the fork busbar rail connecting the live terminals together. Replace the end cap and reinstall the busbar to link the **two neutrals together** - ensure the busbar has been connected correctly. Install the **L1 & Neutral** cables in to the cable input terminals of the right MCB (**Door A**), now install the **L2** cable into the left MCB (**Door B**). Connect the CPC to the Earthing Terminal at the top of the DBOX.



**IMPORTANT! 5 core supply cable is recommended for a polyphase supply to ensure a dedicated CPC identified by green & yellow sheathing is provided. Please ensure spare conductors are safely terminated.**

## Single-phase (T7) Installations - continued

### Dual Supply (2x 40A, 1P) 2x 3-Core Cables 2x (1P + N)

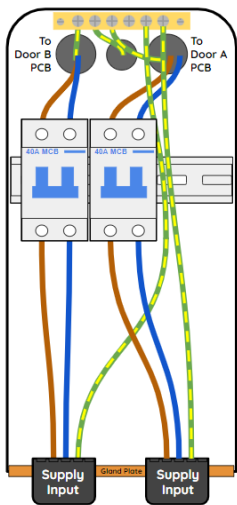

Route the supply cables into the DBOX through the cable glands. Remove the pre-installed 2-Pole 4-way Fork Busbar. Connect the first supply **Live & Neutral** to the cable inputs of the Left MCB (**Door B**). Then connect the second supply **Live & Neutral** to the cable inputs of the Right MCB (**Door A**). Connect both CPC's to the Earthing Terminal at the top of the DBOX.

### Dual Supply (2x 40A, 1P) 1x 5-Core Cables 2x (1P + N)

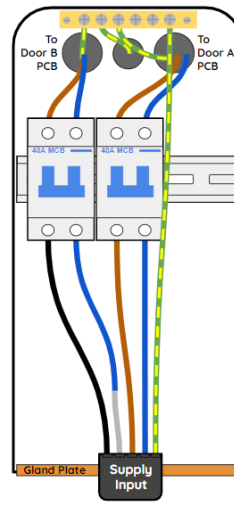

Route the supply cables into the DBOX through the cable glands. Remove the pre-installed 2-Pole 4-way Fork Busbar. Connect the designated supply cables (circuit 1) to the input terminals for **Live & Neutral** of the Left MCB (**Door B**). Connect the designated supply cables (circuit 2) to the input terminals for **Live & Neutral** of the Right MCB (**Door A**). Connect the CPC to the Earthing Terminal at the top of the DBOX.



Ensure 5 core cables have been identified as per the colouring scheme defined in BS 7671 (514.4)

## Three-phase (T22) Installations

Three phase T22 Twin Chargers require a 3 Phase + Neutral 400V AC supply capable of supplying 32A per door. This can be achieved using a **Single Supply** or a **Dual Supply** (2x 3 phase supplies). Cables must be suitable for the installation method chosen and be adequately protected against mechanical damage / stress. Circuits and supply cables must be able to carry the nominal load current and combined prospective fault current for the Twin Charger. The Twin Charger must be protected against overcurrent and fault at the source of supply by a suitably rated MCB, MCCB or fuse (see below for current ratings).



**DANGER!** If the Twin Charger is to be connected to a TT earthing system, an RCD must be provided at the source of supply.

Where there is a requirement for an RCD to be fitted in the supply circuit for example where a TT earthing system is being used, it must be of time delayed type with a rating over >100mA to avoid conflict with the in-built 30mA RCDs - for single supply and polyphase arrangements the RCD must be **type B**, for dual supply arrangements the RCD should be at least **type A** - **type AC RCDs must not be used**.

## Three-phase (T22) Installations - continued

### Three-phase Single Supply (80A) 3P + N

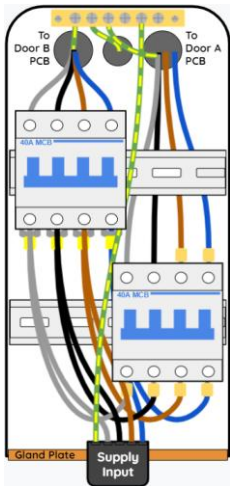

Install the **Neutral, L1, L2** and **L3** cables in to the cable inputs of the top MCB (**Door B**). These should be pre-connected to the lower MCB (**Door A**) via a jumper loom in the busbar inputs. Connect the Earth Cable to the Earthing Terminal at the top of the DBOX.

### Three-phase Dual Supply (2x 40A) 3P + N

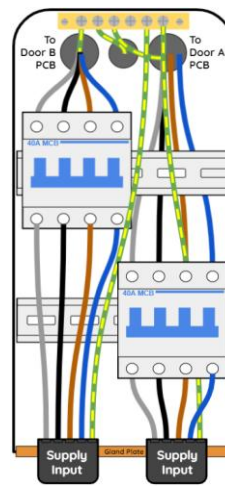

Remove the pre-installed jumper loom connecting the inputs of **Door A** and **Door B** MCBs. Then connect the first supply to the cable inputs of top MCB (**Door B**) and the second supply to the cable inputs of lower MCB (**Door A**). Connect both Earth Cables to the Earthing Terminal at the top of the DBOX.

## Installation finalisation & checks

Following the installation of the supply cable(s) in accordance with the selected Twin Charger and chosen supply wiring configuration, connect the Earth fly lead located in the bottom of the Twin Charger chassis to the connection point on the foundation adaptor - this connects the chassis to the Earthing terminal.

Carry out a post connection inspection of the charger, ensuring:

- Cables and busbar links are located in the correct terminals
- Cables and busbars links have been tightened to the specified torque setting
- Supply cables have been installed using an appropriate cable gland
- Supply cables are free from damage
- Supply cables have been identified correctly
- The Twin Charger has been fixed securely to the foundation
- The ingress protection foundation seal has been fitted

**NOTE:** If the on-site supply capability is not adequate for an installation, the Twin Charger may be remotely derated from 22kW to 11kW or 7.4kW to 3.6kW. If this is required, you will need to replace the main decal sticker on the lid of the Twin Charger to indicate the true charging rate of 11kW or 3.6kW.

---

## Electrical testing

Upon the completion of the installation or relocation of the Twin Charger, the installer must carry out initial verification and testing of the supply circuit(s) as set out in BS 7671, Pod Point recommends that the following additional tests are conducted with results recorded:

- RCD tests (x1 and x5) on both vehicle connector sockets (A and B)
- 6mA RDC-DD (DC leakage) ramp test on both vehicle connector sockets (A and B)
- Earth loop impedance (Zs) tests on both vehicle connector sockets (A and B)

Certification should be issued to the client upon completion of the installation.

## Pre commissioning

Visually inspect the Twin Charger to ensure:

- Supply cables are adequately glanded and secured into the charger.
- There is no damage to supply conductors
- Internal MCBs have been switched into the “ON” position
- The DBOX cover has been refitted
- Earth fly leads are securely attached
- The ingress protection foundation seal is fitted correctly

Refit the rear access door, ensuring a small amount of anti-corrosion grease is applied to the door fixing bolts.

Ensure the foundation ground plate is securely fixed with bolts / nuts tightened to the correct torque value (see fixing manufacturer data), confirm that the foundation fixings have washers fitted and that one of the methods below is being used to ensure the Twin Charger does not become loose over time:

- Thread locking compound applied to foundation threads
- Nuts with Nylon insert used
- Locking nuts used
- Spring washers used

The Twin Charger can now be powered on ready for commissioning.

## Connecting to Wi-Fi

For installations including Twins with Routers, the Twin Chargers should automatically connect to the locally created Wi-Fi network.

Alternatively, to connect the Twin Charger to a site Wi-Fi network follow the below steps:

1. Obtain the site's Wi-Fi network SSID and Wi-Fi password key (usually found on the Wi-Fi router)
  2. Switch 1 side of the Twin Charger on, by turning on 1 out of 2 MCBs, while the other one is turned off.
  3. Scan for **podpoint** Wi-Fi network on a mobile device and connect to it.
  4. Open the web browser and type the IP address: **192.168.101.1** followed by enter.
  5. A page displaying available networks will show. Select the desired network and enter the network password. Press "Connect" at the bottom of the page.
- Note: The page will remain displayed but inactive after "Connect" has been pressed.
7. Turn the power on and off if the connection fails and wait for 1 minute.
  8. Follow the same procedure to connect the second side of the Twin to the Wi-Fi.

When a connection has been made, the door LEDs should go blue flashing pink. If the LED remains white, you may need to power cycle the charger again and verify the settings.

**NOTE:** the Twin Charger connects to a secure server, all data is encrypted using a unique algorithm.

## Commissioning of Twin Chargers

Visit the PP Install App to commission this charger. If you do not have access to the Pod Point App, please visit:



[pod-point.com/3rd-party-commissioning](https://pod-point.com/3rd-party-commissioning)

## Testing of Functionality

In order to test the functionality of the sockets of the twin, the back door must be fully closed to ensure the tamper detection is not activated. If it is not fully closed you will see a red flashing yellow sequence.

When power is turned on, lights on both sides of Pod Point Twin Charger should change colours as follows:

1. Establishing communication with server (takes up to 1 min) - White
2. Communication established, car not plugged - Blue flashing pink

An EV Simulator should then be plugged in to both sockets and the Twin Charger's functionality should be tested as follows:

1. Unlock mode (State A) - Blue flashing pink
2. Standby (State B) - Flashing green
3. Charge (State C) - Green
4. Fault - Solid or Flashing Red

If the test procedure fails at any stage please contact Pod Point.

General installation guide documentation can be found here:



## Maintenance

The Twin Charger requires ongoing maintenance to ensure it remains safe for continued use and to ensure longevity. Maintenance tasks should only be carried out by suitably qualified and competent persons.



Pod Point recommends that the internal RCDs within the Twin Charger should be manually checked for operation **every 6 months** in line with recommendations within BS 7671 - this manual check should only be carried out by a suitably qualified and competent person.



Pod Point recommends that the Twin Charger is inspected and tested at least **every 12 months** by a suitably qualified and competent person, these checks will ensure the internal safety devices are operational - these tests apply to internal features only and not any devices included in the supply circuit which should be tested in line with the relevant Electrical Installation Condition Reporting (EICR) Schedule.

In very high use locations, it is recommended to increase the inspection frequency to **every 6 months**. It is the responsibility of the installer to assess the requirement to inspect more frequently than every 12 months and to notify the owner of the Twin Charger accordingly.

Pod Point recommends using our authorised engineers for all inspections and maintenance requirements. Failure to do so may invalidate the product warranty - please check the Pod Point Warranty Terms and Conditions for more information on this. To arrange a service visit by a Pod Point authorised engineer, please contact us via:

[www.pod-point.com/contact](http://www.pod-point.com/contact)



pod POINT