

pod POINT

Solo Pro

Instructions for installation

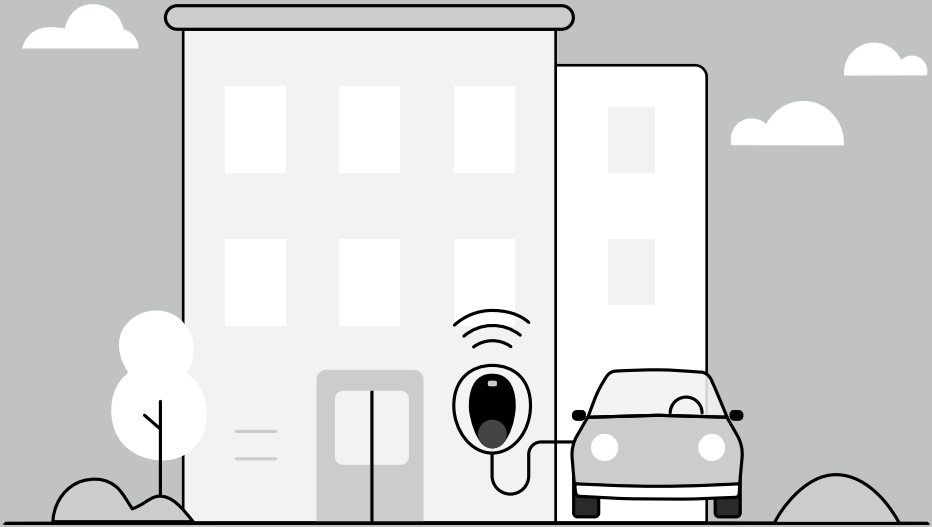



Important legal notice

Pod Point is not responsible for the installation and/or commissioning works performed by any installer who is not us or our appointed install partner.

In the absence of any negligence or other breach of duty by Pod Point or our appointed install partner, Pod Point is not responsible for any injury, loss or damage caused by any works, services, products or equipment provided or performed by the customer or the customer's third-party installer in relation to the installation, moving, modification, re-wiring and/or commissioning of the chargepoint.

Any installation or commissioning must comply with Pod Point's latest technical guides and recommendations, available from podenergy.com/technical/hardware.

If Pod Point or our appointed install partner does not perform the installation and/or commissioning of the charger, it is the customer's responsibility to ensure that any third-party appointed to install, commission, move, modify and/or re-wire the chargepoint meets all technical Standards reasonably required to carry out such work. These Standards include, but are not limited to, compliance with the latest edition of BS 7671 and Part 722 of the same Standard for all electrical installation work, which refer directly to electric vehicle charging installations.

Installation of Pod Point charging equipment must comply with all applicable Building Regulations and Standards (including Part P of the Building Regulations for works in England and Wales) and must be carried out by a Competent Persons Scheme (CPS) registered installer.

Pod Point requires that any individual or business engaged in installing, commissioning and notifying for Part P of the Building Regulations be registered with a CPS, and whose remit and scope of works include electric vehicle charge point (EVCP) installation and commissioning. Pod Point only recognises the following CPSs:

- National Inspection Council for Electrical Installation Contracting (NICEIC)
- Electrical Contractors Association (ECA)
- National Association of Professional Inspectors and Testers (NAPIT)
- The Electrical Contractors Association for Scotland (SELECT)

Do not open, move, modify, or rewire your chargepoint and associated components once it has been commissioned. Failing to adhere to these requirements may affect any warranties in place for your chargepoint.

Welcome to the Solo Pro

This guide will walk you through the setup process step by step.

It is designed to ensure an effortless installation, optimising performance and reliability.



Charger information

The Solo Pro charger is appropriate for workplaces and shared residential properties. It should not be used for individual dwellings where the power supply is located inside the property. This charger does not support the optional function for ventilation.

The Solo Pro is designed to be permanently connected to a TN-S, TN-C-S or TT AC supply network. It only provides an AC charging output.

Feature	Description
Charging Type	Mode 3
Connector	Universal - Type 2 Socket (IEC 62196-2)
Electric Shock Protection	Class I - When charging Class II - When not charging
Rated Voltage	230V (400V) 50Hz
Rated Current	Up to 32 A per phase
Operating temperature	-25°C to 40°C. Charging speeds may be reduced during high temperatures to protect the device
MID meter accuracy (optional)	Class B (+/-1%) to IEC62053-21/-22
Types of earthing system	TN-S, TN-C-S or TT
Ingress Protection Rating	IP54 (Outdoor or Indoor Use)
Impact Resistance Rating	IK10
Overvoltage (installation)	Category III
Pollution Degree	3
Product Dimensions (H x W x D)	330mm x 290mm x 167mm
Weight	Up to 4.2kg
Radio Frequencies & EIRP - Router	Mobile:698-960/1710-2690 & 33dBm@GSM,24dBm@WCDMA, 23 dBm@LTE Wifi:2400-2500MHz & 20dBm
Radio Frequencies & EIRP - Main board WiFi	2400-2483.5MHz & 6dBm

For optimal performance and improved longevity, our chargers are typically rated at 7kW. This rating can be increased to 7.4kW upon request.

In the box



1 x Solo Charger

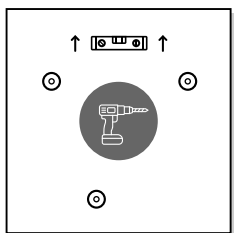

1 x Drilling Template



1 x Installation guide

If any items are missing or damaged, please visit www.pod-point.com/fault

Before you start

1 You'll need

- Drill
- Appropriate mounting screws and plugs
- Supply cabling and related cabling support materials
- Appropriate circuit protection
- Cable glands, grommet or sealant
- Cable ties
- EV simulator device
- Multi-function tester
- M20 Gland for optional Ethernet (LAN) connection

2 Download the App

Download the Pod Point Installer App to complete the installation and register the charger. Failure to do so will impact the charger's warranty. It also means Pod Point's customer service team cannot deal with customer issues on your behalf.

Scan the code to download the app, or visit podenergy.com/installer-app

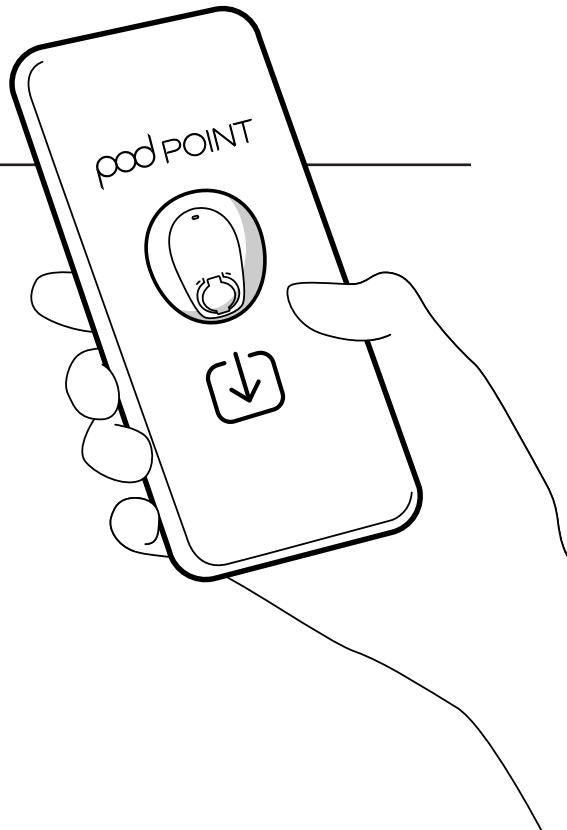

Wiring diagrams

3P Solo Pro & dedicated circuit

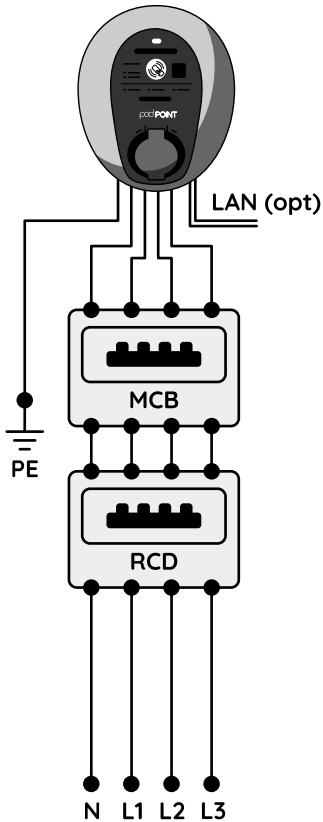

Fused supply network

1P Solo Pro & Array load management

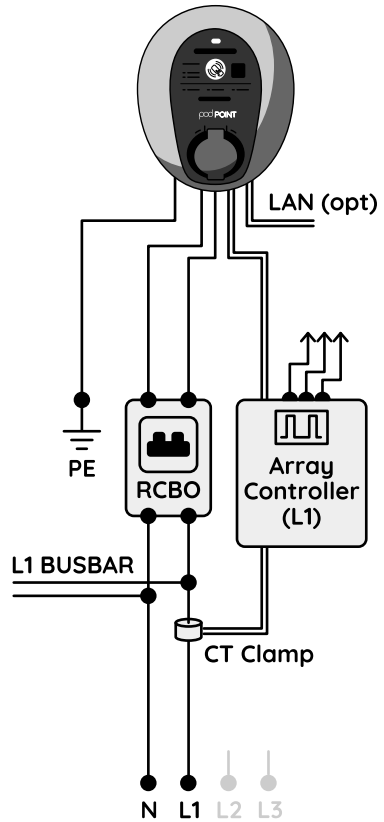

Fused supply network



See "Choose the right circuit protection" section for further details.

If supply is limited, you can use a CT clamp.
The CT is not available where an Array system manages available energy.

Solo Pro & CT clamp

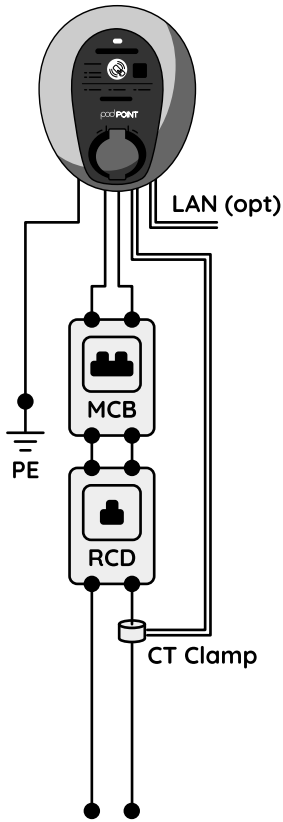

Fused supply network

Solo Pro, CT clamp & consumer unit

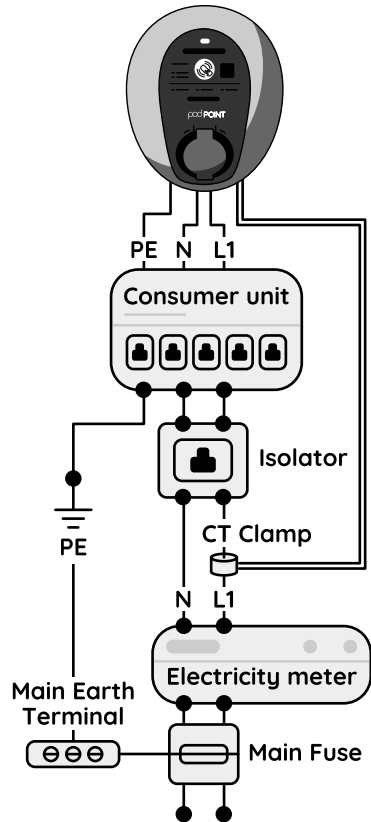

Fused supply network



If wiring through a consumer unit, do not use single-pole switching devices.

Prepare for installation

Choose the right location

- ✓ Choose a flat, hard and permanent surface.
- ✗ Do not use fences.
- ✓ BS 8300-1:2018 states there must be at least 750mm between the ground and the centre line of the socket outlet.
- 👁 Consider parking location, trip hazards and cable lengths.

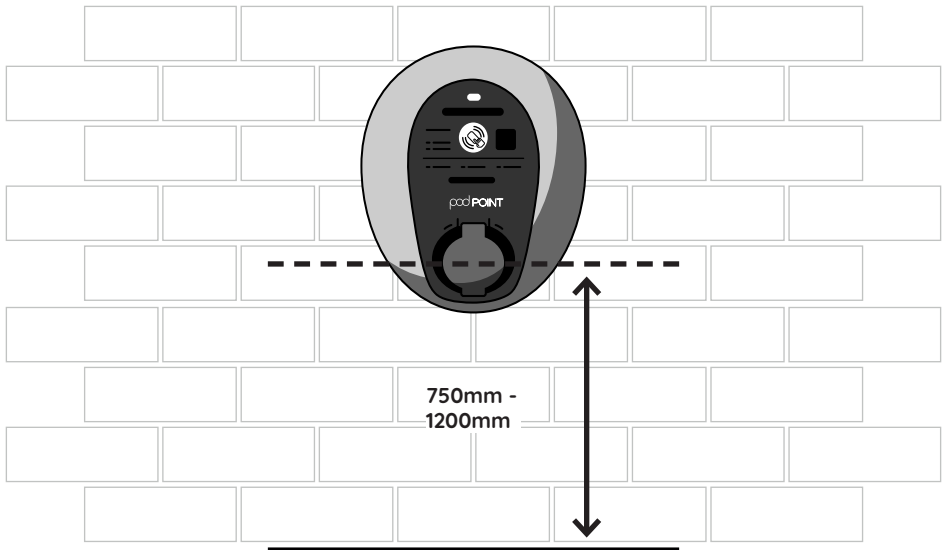

Conduct initial checks

- ✓ Check the supply voltage and resistance at supply (Z_e). Ensure that adequate bonding is present and there are no issues with either the looped or reportable supply.
- ✓ Follow ENA Guidance to configure the current rating correctly.

Choose the right circuit protection

- ✓ The installation needs short circuit, overload and residual current protection. You should also consider selectivity.
- ✓ Use an RCD along with an MCB or an RCBO, depending on connection type and location.
- ✓ RCDs must be 30mA Type A, Type B or Type F and must switch both poles.

MCBs must be 6kA interrupt rated, class 3 devices.

Most 7kW installations are rated at 40A. But this rating depends on the installation type and grouping factors. MCBs must be curve B or curve C.

6mA DC protection is provided within the charger.

- 👁️ You can also use an RCBO instead of an RCD/MCB combination. The RCBO must be a double-pole switched device and disconnect both Live and Neutral conductors.

Mount the charger

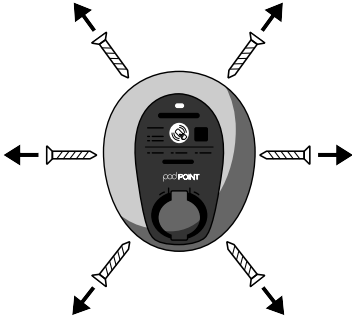

1

Open the charger

Remove the casing screws to open the front of the charger.

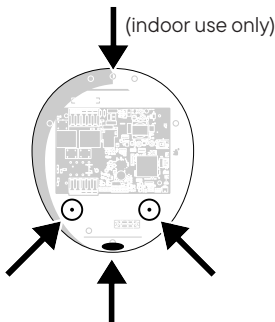

2

Choose a supply cable entry point

There are four* possible entry points for the supply cable.



* Top entry point is NOT available on units fitted with MID meters

3

Drill a supply cable hole

Drill a hole into your chosen entry point. Take care not to damage any internal wiring or components.

You must use a grommet, gland and/or sealant to seal the hole to maintain the products IP rating.



If you damage the components or wiring do not connect the charger. Contact Pod Point for advice.



Grommet or gland must be used for bottom entry.

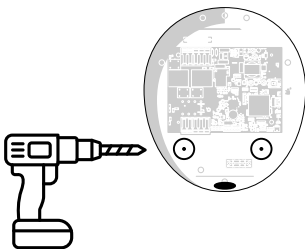

4

Choose your fixings

The type of fixing will depend on the mounting surface. For common brick walls, we recommend using:

- Mushroom, flanged or pan head screws
- 3 x No.12 (Diameter 5.5mm) x 35mm long self-tapping screws
- 3 x Suitable wall plugs (for diameter 4.5-5.5mm screws)



Do not use countersunk head types.

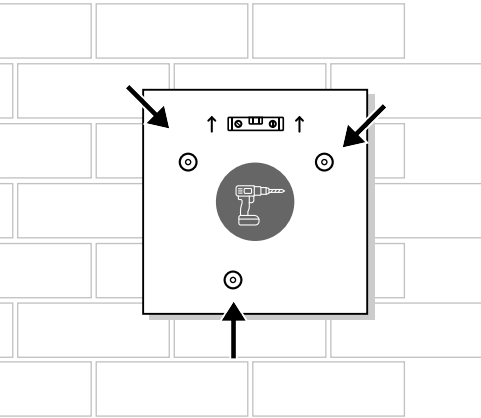

5

Drill the mounting holes

Check the surface for cabling and pipework. Use the drilling template provided to drill three holes and fill with plugs if needed.



Do not use the holes in the charger as a drilling guide. Masonry dust will damage the internal components.

6

Secure and seal

Secure the charger to the mounting surface using the three fixing points.

Each mounting point is pre fitted with an O-Ring Seal.



Please exercise caution and fit the mounting screws slowly to minimize the risk of buckling the O-Ring Seal's. DO NOT use power tools and ensure the seal remains fitted correctly.

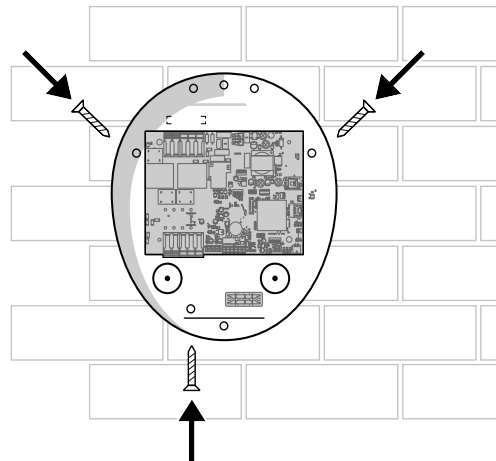

Prepare to wire the charger

1 Choose a supply cable

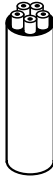

- 40A minimum current
- BS 7671 compliant
- Up to 16mm² cable
- Respect **cable bend radius**
- Long enough** so it doesn't pull on the cables, PCB or MID Meter

2 Remove insulation from the supply cable



Remove insulation so it is easier to thread into the charger

Leave 10mm minimum where it enters the charger to avoid chafing

3 Remove insulation from the wires

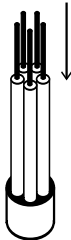

Remove 15mm minimum from the ends of the wires within the supply cable.

4 If the charger has a router, remove it

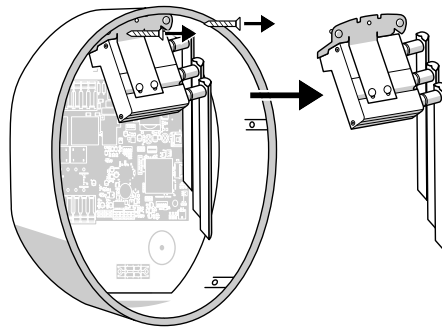

Disconnect the wiring from the router.

Wire the supply to the charger

Choose the wiring set up that's best for your installation

Supply only

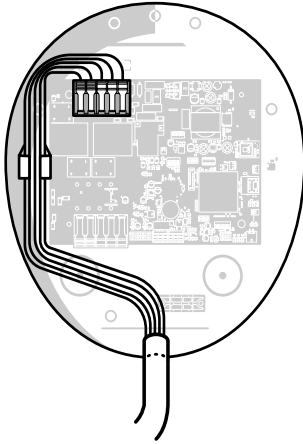

With MID Meter

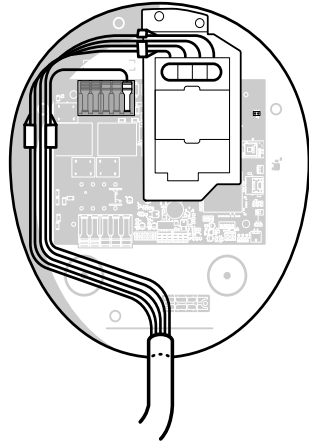

With CT Clamp

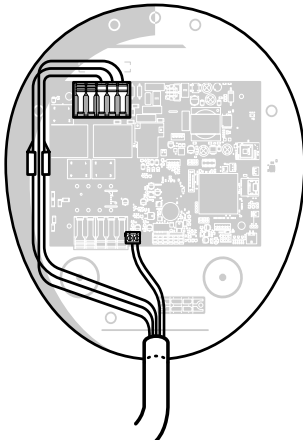

With Array

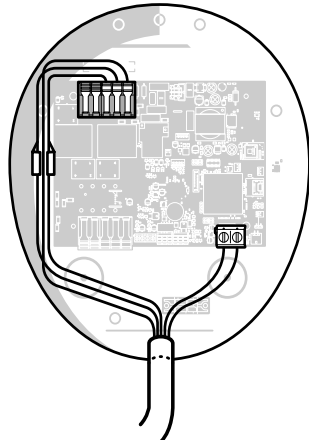

If using Supply only



Avoid damaging the PCB:

- Only touch the connection terminals
- Only use light force

Wire the supply to the charger

Clamp the 3 or 5 wires into the connection terminal



When utilising SWA cable, the armour should not be terminated at the EVSE end but at the DB end.

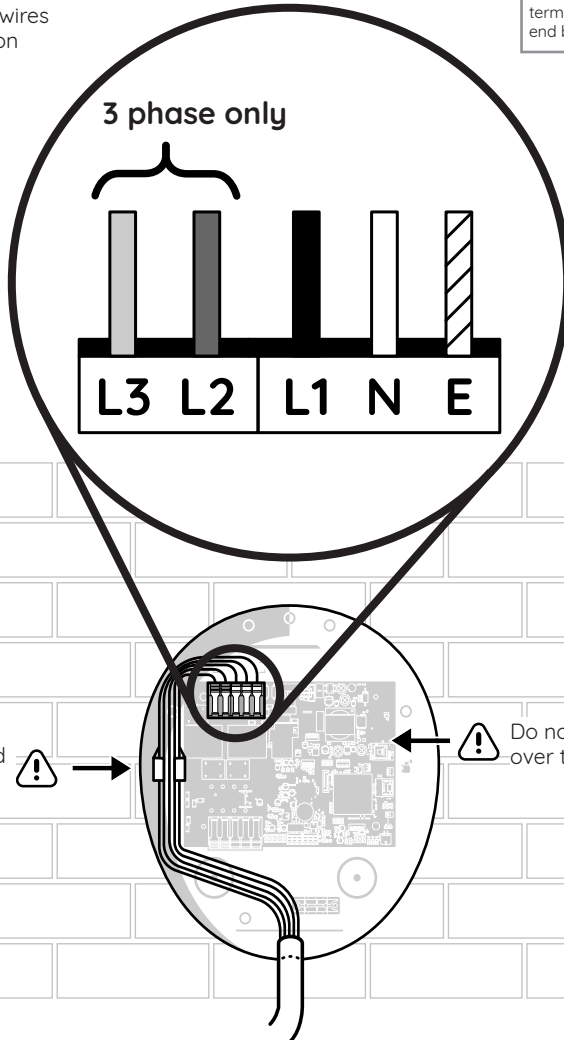

If wiring with MID Meter



Avoid damaging the PCB:

- Only touch the connection terminals
- Only use light force

Wire the supply to the charger

Clamp the PE and screw the remaining 2 or 4 wires as shown.

The torque to screw the wire to the MID Meter must be 2.5Nm.

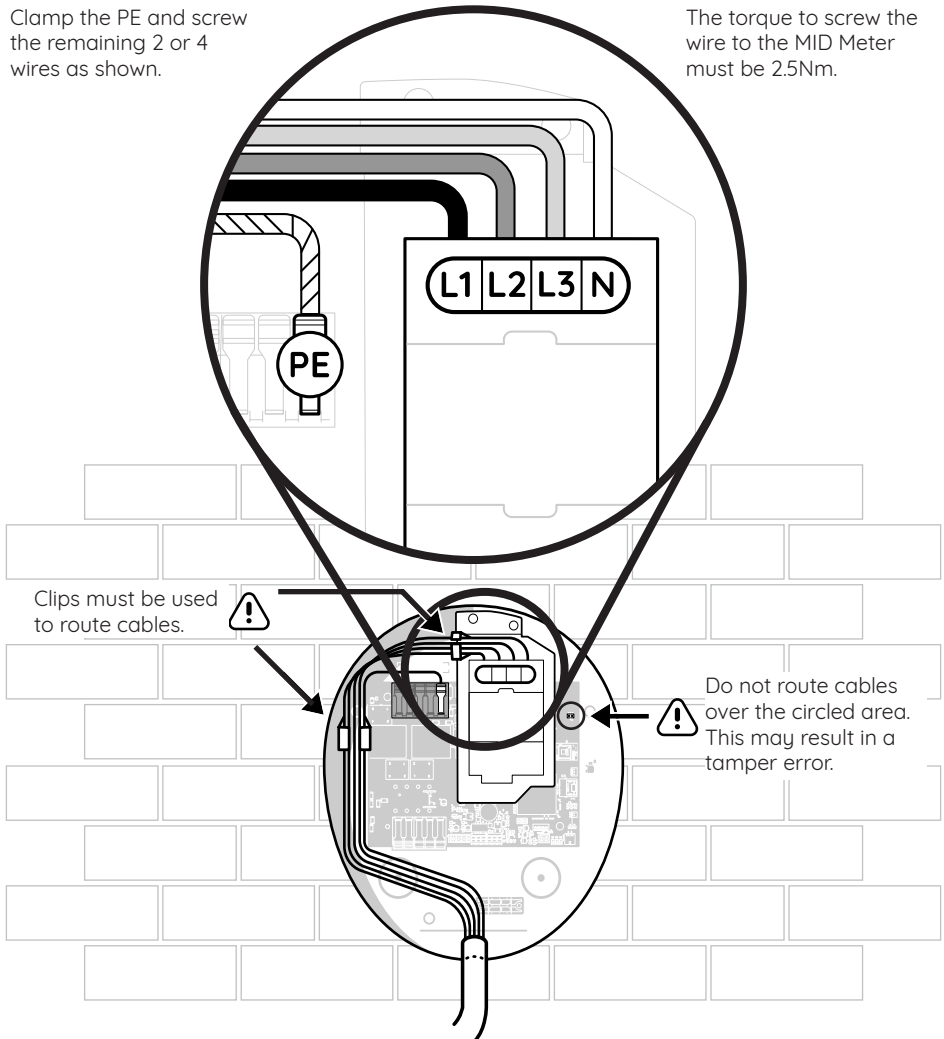

If wiring with CT clamp

! Avoid damaging the PCB:

- Only touch the connection terminals
- Only use light force

Only needed for single-phase installations

CT clamps monitor the amount of current going into a property. It protects the upstream main fuse from overload by allowing the charger to re-rate when needed.

1 Clamp it to the incoming supply feed

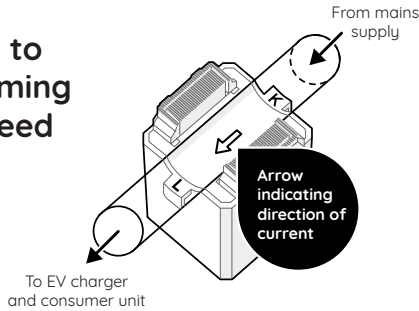

✓ Upstream of any additional power supplies.

! The CT clamp has an arrow on it. This should be pointed in the same direction as the flow of electricity.

2 Wire it to the charger

Use a screened, 2-core Defence Standard cable to wire the CT clamp. Direct connection is acceptable.

Remove the connector and wire the CT clamp to it, tightening to a torque of 0.5Nm. Do not over-tighten as this will damage cables and terminals. Plug the connector back into the board.

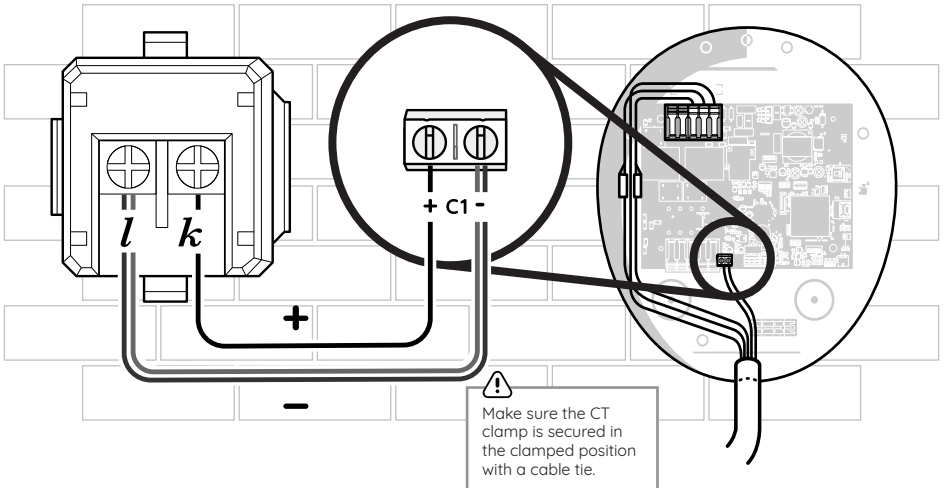

If wiring with Array



Avoid damaging the PCB:

- Only touch the connection terminals
- Only use light force

For multiple chargers on the same power supply

An Array Controller is needed for the external control output signal. It will ensure that supply is shared equally. Power balancing features will not work without it.

BS 7671 states the voltage rating of the cable must be the same as the supply cable if it's located in the same containment.

1

Connect the screened cable

Connect the screen or "braiding" of the signal wire to the "-" terminal of the terminal block marked ARR.



The Array connection is isolated on the board. No upstream PEN fault protection is required.

Screened cable

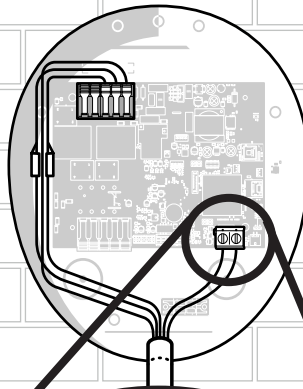

2

Wire the Array Controller

Use a screened, 2-core Defence Standard cable. Direct connection is acceptable.

Remove the connector and wire the Array to it, tightening to a torque of 0.5Nm. Plug the connector back into the board.



Do not over-tighten the torque. This will damage the cables and terminal.

If daisy chained, connection to next charger

Set up the Ethernet (LAN) interface

Solo Pro is equipped with a Ethernet (LAN) interface. This is used when no WiFi or 4G signal is available. The Ethernet (LAN) interface is a standard 10/100 RJ45 (up to 100mbps).

- ✓ Use unshielded Cat 5 cables.
- ✗ Do not use a shielded (Screened) LAN cable.
- ✗ Avoid kinks or sharp bends in the LAN cable.
- 👁️ Adhere to a maximum distance of up to 100m.
- ✓ You will need to drill on the flat surface of the rear casing right hand side a hole for a M20 gland.
- ⚠️ Keep enough clearance from the PCBA. Drill no deeper than 25mm into the enclosure.
- ✓ Use an M20 gland to seal the hole to maintain the products IP rating.

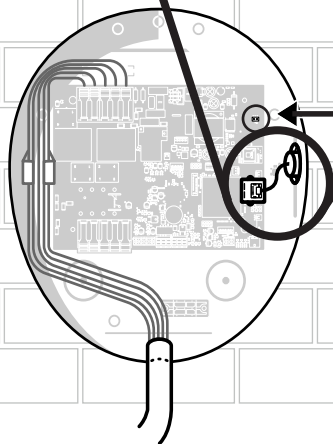
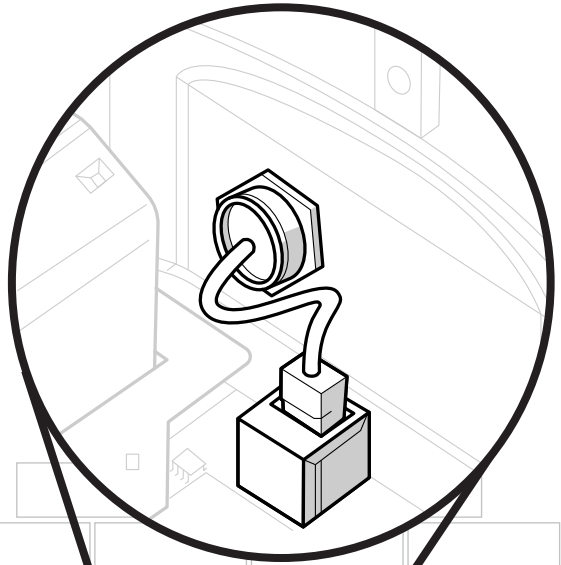

⚠️ Do not route cables over the circled area. This may result in a tamper error.

Take photos of the wiring

Take pictures of the charger before closing it. You will need this during the registration process.

Take photos of:

- ✓ The inside of the charger, showing the terminal connections
- ✓ The wiring of the CT clamp (if installed)
- ✓ The circuit protection used and associated wiring
- ✓ The wiring of the Array Controller (if installed)
- ✓ The closed charger, from a distance



If you do not supply these images, Pod Point cannot take ownership of the charger. You will be responsible for future customer support enquiries.

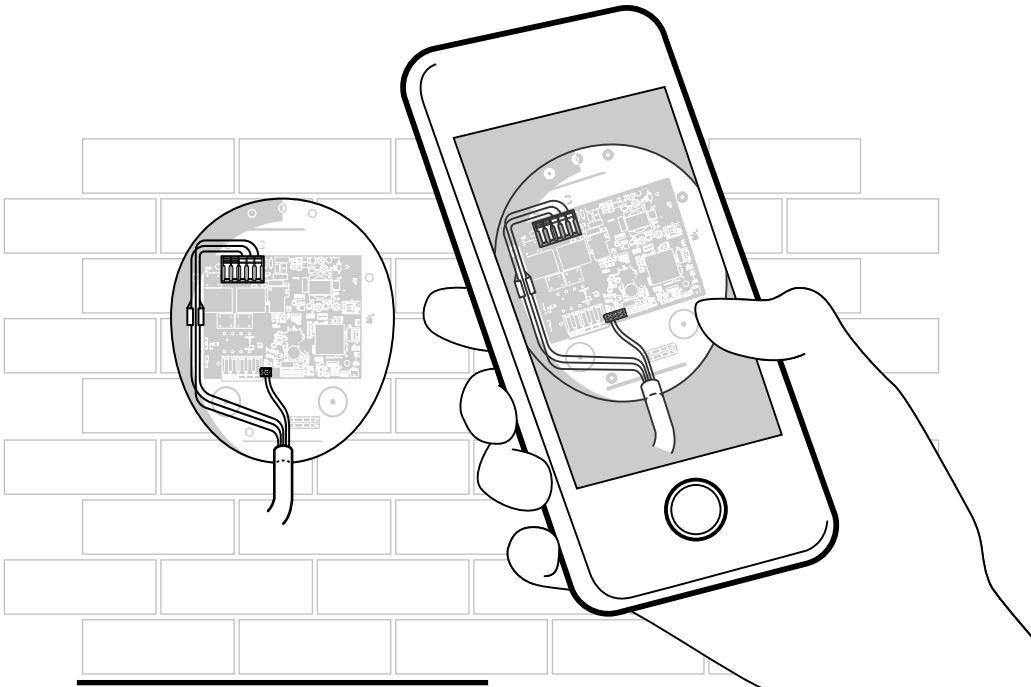

Close the charger

- 1** If the charger has a router, reattach it

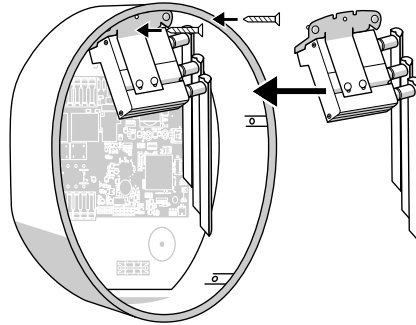

Reattach and reconnect the wiring to the router.

Set it up once the mains cable has been connected.

- 2** Close the charger

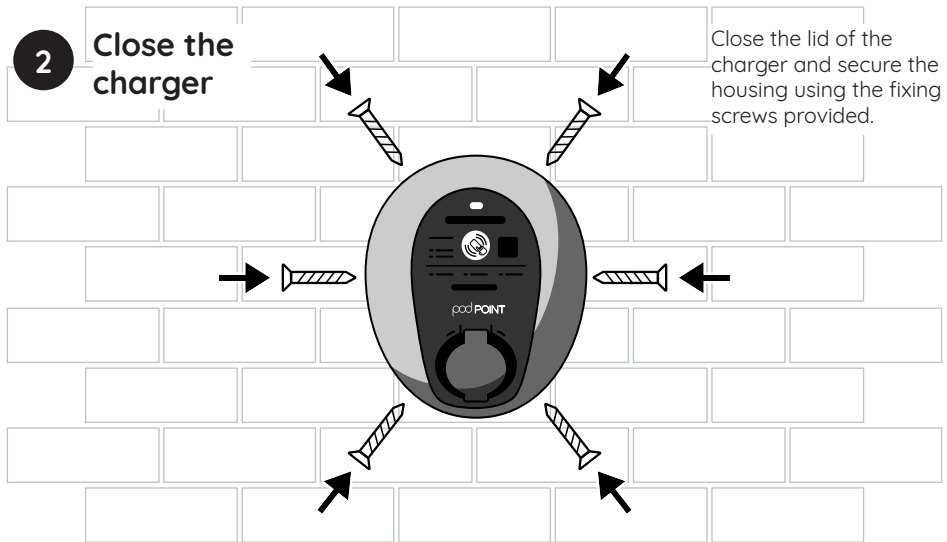

Close the lid of the charger and secure the housing using the fixing screws provided.

Setup and register the charger

Use the Pod Point Installer App to complete the installation and register the charger



Scan to download

or visit
[podenergy.com/
installer-app](https://podenergy.com/installer-app)

Complete these steps in the App:

- Create an account if you don't have one already
- Allow location permissions for connection to the WiFi
- Connect to the charger
- Configure the charger
- Test the charger
- Connect to the WiFi
- Register the charger and submit the photos you took earlier

Also in the App:

- Troubleshooting
- LED guide

Functional testing

Testing with an EV

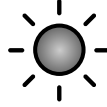
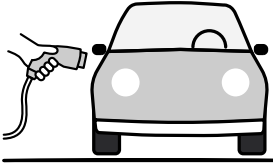

Connect the charger to an EV
The status light on the charger should turn **solid green**.



Leave on charge for 2 minutes
to confirm charger is working as expected.

Or if using an EV simulator

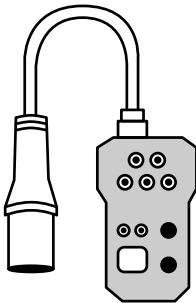

Before plugging in set your simulator to Off, State A or Unlocked.



Insert the EV simulator into the charger.

Change the setting to State C.

If the light turns **solid green**, it's charging and the cable is locked into the socket.



Choose a suitable load and leave for 2 minutes.

The charger's LED should stay **solid green** throughout.

The Main Fuse Current should also increase accordingly. This shows that the CT clamp or Array Controller is working.

Declaration of Conformity

UKCA

- Hereby, Pod Point Ltd declares that the radio equipment type, Solo Pro, is in compliance with The Radio Equipment Regulations 2017.

The full text of the UKCA Declaration of Conformity is available online at:

podenergy.com/technical/hardware

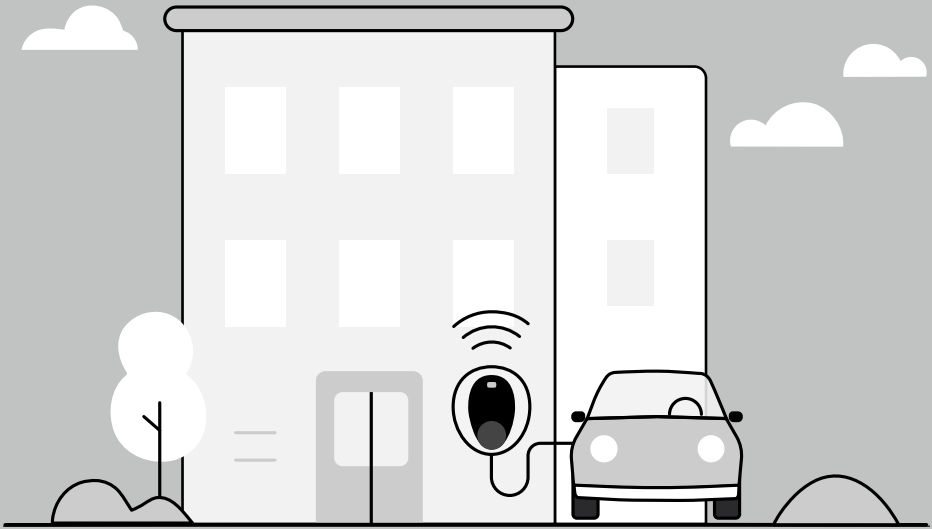

Need help? We're here for you.



Visit our
online help centre
help.pod-point.com



Contact our
technical support teams
020 7247 4114